

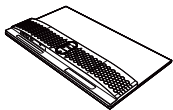

# EA241S

## User Manual

# Parts List



Monitor x1

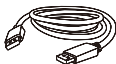

DP Signal line x1



Stand x1

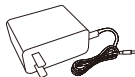

Power adapter x1

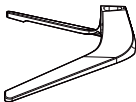

Base x1

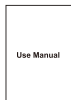

User Manual x1



Decorative cover x1



Screw x3

\*Because the interface of the model is different, the standard accessories are different, the specific accessories are subject to the actual product in the package

# Quick start

1

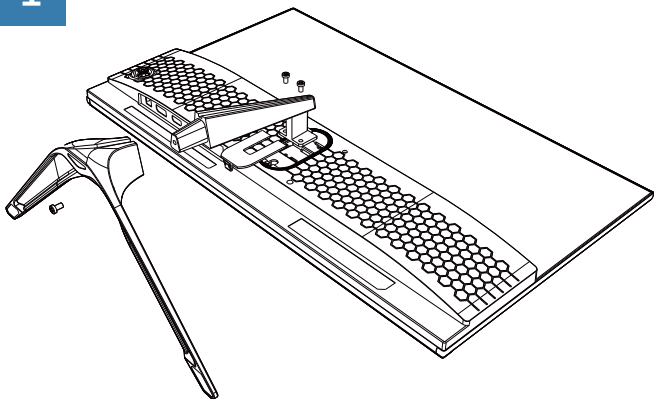

Install steps:

Take out the bracket, align it with the interface on the back of the display, insert two screws and tighten it with a screwdriver;

insert the base interface into the bracket, insert a screw, and tighten it; finally put the decorative plastic cover in and fasten it Can.

2

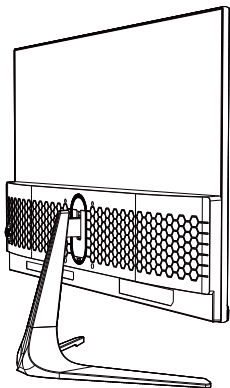

$15^{\circ} (\pm 2^{\circ}) \leftarrow 0 \rightarrow 5^{\circ} (\pm 2^{\circ})$

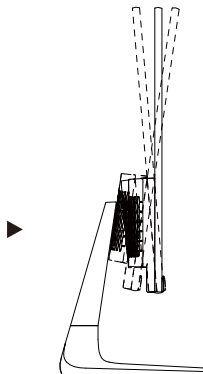

Stand the monitor up and adjust the tilt angle of the monitor as needed

# 3

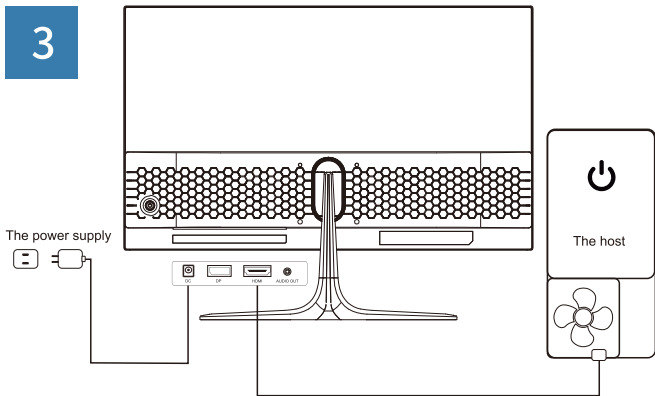

## Instructions

1. Connect the power cord.
  2. Connect the signal line to the PC.
  3. Press the power switch, the power indicator light is on. (Blue light when power on, blue light flashes when standby, no light when power off)
- Press the power switch to turn on and off the display. By operating the corresponding function keys, you can adjust the OSD menu to get the settings you need. See menu operation for details.

\* Some cables need to be purchased separately.

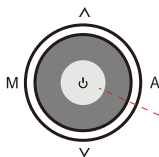

One-key five-function joystick button

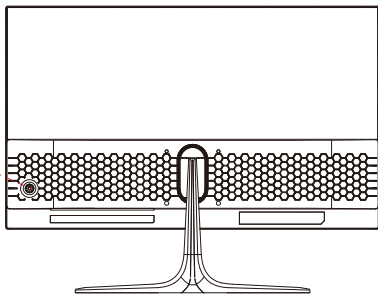

### Joystick button control key description

M	Menu
^	Preset mode
v	Signal switch
A	Return/Exit
⏻	Power switch

### Button Description

1. "M" activates OSD menu and confirms.
2. "^" Preset mode/Select items and adjust parameters upward in the menu.
3. "v" Signal switch/Select items and adjust parameters downward in the menu.
4. "A" Menu return or exit/VGA Auto Adjust/ Game plus Crosshair.
5. "⏻" Switch monitor power  
Single press once to power on,  
long press for 3 seconds to power off

# Safety Precautions

## Notice

- Outlets should be installed near the equipment and should be easily accessible.
- For equipment with an AC switch, use the AC switch as the disconnecting device.
- For equipment without AC switch, use the power plug or appliance coupler as the disconnecting device, and ensure that the disconnecting device is easily accessible during normal use of the equipment.
- If consumers use power adapter for power supply, they should purchase a power adapter that has been certified by CCC and meets the standard requirements.



- Please put the unit on a stable surface, otherwise it will be damaged by falling.



- The altitude and tropical environment used by the adapter model are determined by the adapter provided. The nameplate on the rear of the whole machine is marked with the above warning signs, indicating that the product is only suitable for safe use in areas with an altitude of 2000m and below.



- Do not use the plug when there is water on your hands, otherwise it may cause electric shock; make sure the plug is in good contact, as poor contact may cause fire.



· Please do not use a damaged power plug, and do not place the power cord near a heat source, otherwise it may cause electric shock or fire.

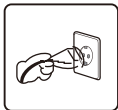

· When the machine is not used for a long time, please cut off the power supply of the machine, otherwise it may cause electric shock or fire.



· When cleaning, please unplug the power supply, and use a soft cloth at the same time, do not use industrial chemicals, and be careful not to let water enter the inside of the machine.



· Please do not disassemble the machine by yourself. If there is a fault, please contact a professional for repair. If you disassemble it by yourself, it may cause electric shock or fire.



· If there is abnormal smell or sound in the machine, cut off the power immediately and contact professional maintenance personnel for maintenance.



# Safety information

Review and follow all safety information before using and operating the equipment to ensure optimum performance and to avoid dangerous or illegal situations.

## Operational Safety and Maintenance

- The radio waves generated by the device may affect the normal operation of implanted medical devices or personal medical devices, such as pacemakers, cochlear implants, hearing aids, etc. If you use these medical devices, please consult their manufacturer for restrictions on the use of this device.
- When using this device, please keep a distance of at least 15 cm from implanted medical devices (such as pacemakers, cochlear implants, etc.).
- Please disconnect the power supply and unplug all cables connected to the device during thunderstorms to prevent the device from being damaged by lightning strikes.
- Do not use this device during thunderstorms. Thunderstorms can cause equipment malfunction or electrical shock hazard.
- Please use the equipment within the temperature range of  $0^{\circ}\text{C} \sim 40^{\circ}\text{C}$ , and store the equipment and its accessories within the temperature range of  $-20^{\circ}\text{C} + 60^{\circ}\text{C}$ . When the ambient temperature is too high or too low, it may cause equipment failure.
- This device and its accessories may contain some small parts, please keep the device and its accessories out of the reach of children. Children can inadvertently damage the device and its accessories, or swallow small parts that could cause choking or other hazards.
- It is not recommended that you upgrade parts or replace modules by yourself. If you have related service requirements, please contact the official customer service.

- Keep the device and its accessories dry. Do not use external heating devices such as microwaves or hair dryers to dry it.
- Do not subject the device and its accessories to strong shocks or vibrations, so as not to damage the device and its accessories and cause device failure.
- Before cleaning and maintenance, please stop using this device, close all applications, and disconnect all connections or cables to other devices.
- Do not use harsh chemicals, cleaning agents or strong detergents to clean the device or its accessories. Wipe the device or its accessories with a clean, dry soft cloth.
- If the device collides with a hard object or the device is subjected to a strong impact from the outside world and the screen is partially broken, do not touch or try to remove the broken part, please stop using it immediately and contact the official customer service in time.
- Do not place any objects (such as candles, water containers, etc.) on the device. If foreign objects or liquids enter the device, please stop using it immediately, disconnect the power supply, unplug all cables connected to the device, and contact the device in time Official customer service.



The numbers in this logo indicate that the environmental protection use period of the product under normal use is 10 years. Certain components may also have an Environmentally Friendly Use Period logo, which is based on the number in the logo.